

# Data Sheet

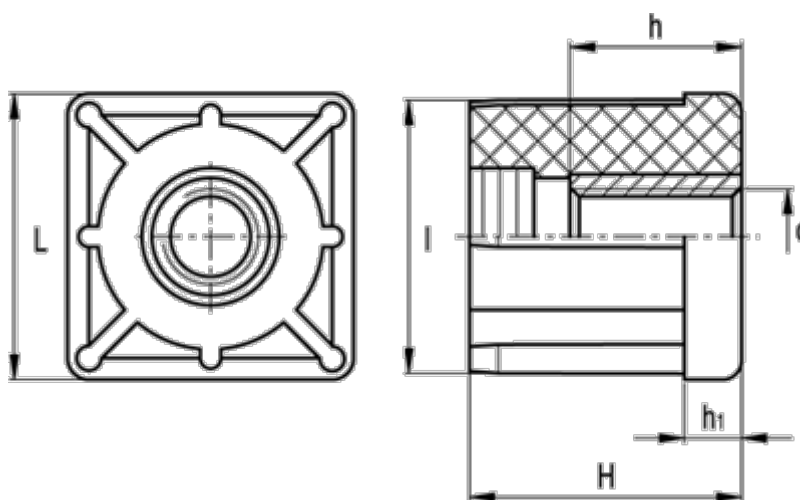

Article number: 2310320041  
Description: E+G Square end-cap  
NDX.Q-30x2.0-M8

## Measures



d	= M8	Tube wall thickness = 2.0
h	= 10	Weight (g) = 28
H	= 31	
h1	= 6	
Internal tube size	= 26.0	
l	= 26.0	
L	= 30	
Outer tube size	= 30	